

|                 |         |           |            |        |
|-----------------|---------|-----------|------------|--------|
| Revision Notes. |         |           |            |        |
| -               |         |           |            |        |
| APA: -          | Drawn:- | Checked:- | Approved:- | Date:- |

**VIEW A**

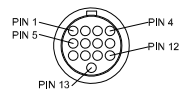

DIN MALE MATING FACE

| PIN # | WIRE COLOUR | DESCRIPTION |
|-------|-------------|-------------|
| 1     | PINK        | CA2 VIDEO   |
| 2     | LIGHT BLUE  | CA2 12VDC   |
| 3     | BROWN       | CA1 TRIGGER |
| 4     | ORANGE      | CA2 AUDIO   |
| 5     | YELLOW      | CA1 VIDEO   |
| 6     | PURPLE      | CA1 12VDC   |
| 7     | DARK BLUE   | CA2 TRIGGER |
| 8     | GREEN       | CA1 AUDIO   |
| 9     | WHITE       | CA2 8VDC*   |
| 10    | CYAN        | CA1 8VDC*   |
| 11    | GREY        | SOFTWARE    |
| 12    | SHIELD      | GROUND      |
| 13    | RED         | 12/24VDC    |
| 14    | CASING      | GROUND      |

\*8VDC IS ONLY SUPPLIED WHEN THE MONITOR IS PUT IN SHUTTER MODE VIA THE OSD MENU.

**CHANGES FROM BASE PRODUCT BE-970WM-M (3350) TO BE-970WM-M(NPL) (6006)**

- CHANGE:**
1. WHITE SILKSCREEN BRIGADE LOGO REMOVED.
  2. BE-970WM-M PD-LBL REPLACED WITH BE-970WM-M(NPL) PD-LBL.
  3. FIRMWARE VERSION CHANGED FROM "ECL-750WP\_BR\_R1.8\_140917\_2C57", TO "ECL-750WP\_NPL\_MP1.8".
- OPERATION:**
1. BRIGADE LOGO REMOVED FROM SPLASH SCREEN.

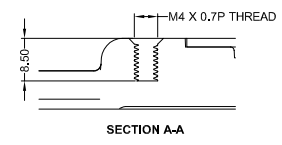
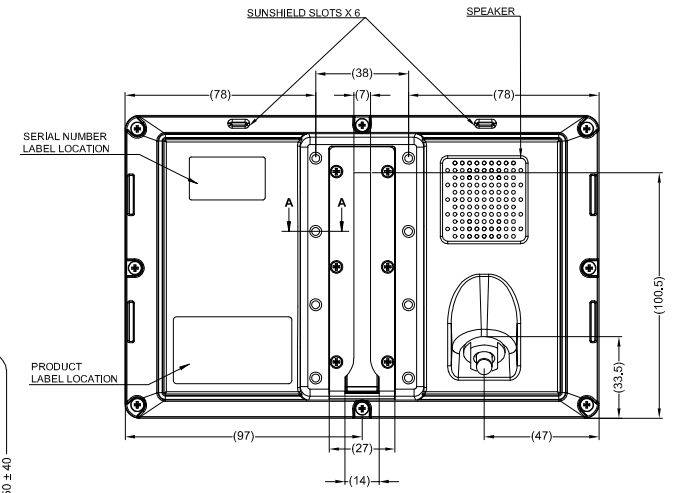
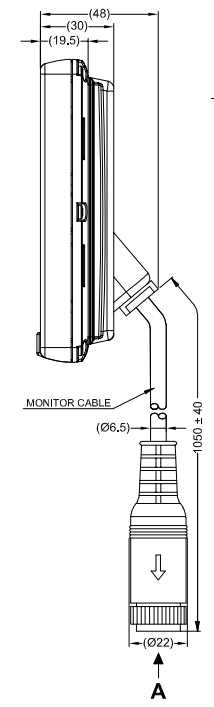
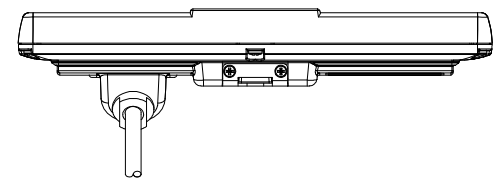
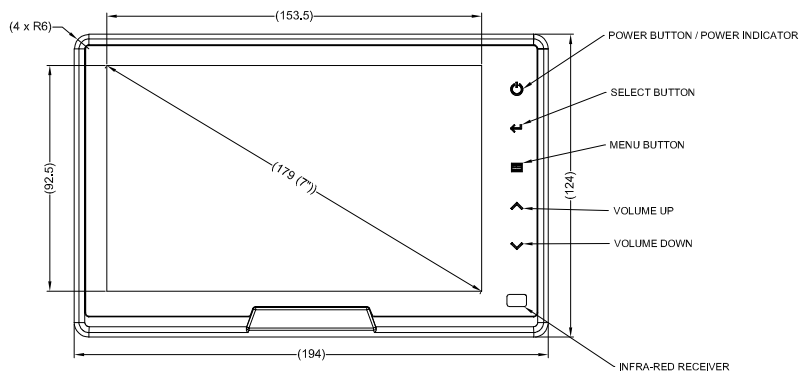
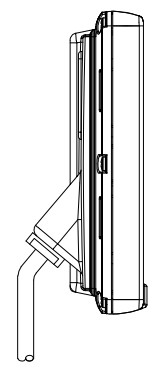
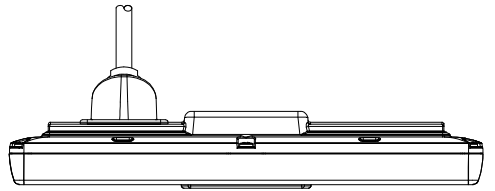

- NOTES:**
1. BRACKET SCREWS TO BE TIGHTENED TO 0.98 NEWTON METRES.
  2. REFER TO PRODUCT SPECIFICATIONS FOR MORE DETAILS.
  3. FIRMWARE VERSION ECL-750WP\_NPL\_MP1.8 CHECKSUM 2C57 TO BE PRE-LOADED DURING MANUFACTURE.
  4. EXTERNAL HOUSING MATERIAL IS ALUMINIUM DIE CAST.
  5. FOR PRODUCT LABEL AND PACKAGING DETAILS REFER TO MASTER BOM.

**PROPRIETARY NOTICE**  
 THIS DESIGN AND TECHNICAL INFORMATION APPEARING ON THIS DRAWING IS THE PROPERTY OF BRIGADE ELECTRONICS, AND IS DISCLOSED IN CONFIDENCE. IT IS NOT TO BE COPIED, REPRODUCED, REVEALED TO OR EXPROPRIATED BY OTHERS, EITHER IN WHOLE OR IN PART WITHOUT THE EXPRESS WRITTEN CONSENT OF BRIGADE ELECTRONICS.



|                                    |                          |                          |                       |
|------------------------------------|--------------------------|--------------------------|-----------------------|
| Assembly Pl Approval<br>T. CHOI    | Approved by<br>B. CHILDS | Checked by<br>J. TYRRELL | Drawn by<br>A. FOSTER |
| Angle of Projection<br>Third Angle | Units<br>mm              | Scale<br>N/A             | Released<br>1812/19   |
|                                    | Status<br>RELEASED       | BE-970WM-M(NPL)          |                       |
|                                    | Part No<br>6006          | BE-004275-00-19          |                       |